

*Article*

## Development of a Solar Photovoltaic Power System to Generate Electricity for Office Appliances

Samuel Babatope Adejuyigbe<sup>1</sup>, Bukola Olalekan Bolaji<sup>1\*</sup>, Mabel Usunobun Olanipekun<sup>2</sup>, and Michael Rotimi Adu<sup>3</sup>

<sup>1</sup>Department of Mechanical Engineering, Federal University of Agriculture P.M.B. 2240, Abeokuta, Nigeria

<sup>2</sup>Dept. of Elect/Elect Engineering, Federal University of Agriculture P.M.B. 2240, Abeokuta, Nigeria

<sup>3</sup>Dept. of Elect/Elect Engineering, Federal University of Technology P.M.B. 704, Akure, Nigeria

\* E-mail: bobbolaji2007@yahoo.com

**Abstract.** In this paper a solar photovoltaic power supply system was developed to power office appliances. The system forms an alternative power source to the government own utility power supply in Nigeria, which is unreliable and epileptic in nature. It consists of photovoltaic array, mounting frame, storage device, inverter, charge controller and wiring system. The solar power system was tested in Akure, Nigeria (Latitude 7.15°N) and the results obtained showed a good performance of the system. The output of solar power system is a function of solar radiation. The power output was high between 10.00 and 16.00 hours, which corresponds to the period of high solar radiation and coincides with the office hours. An average solar power output of 334 watt was obtained during test, while the total load of office appliances carried by the system was 290 watt.

**Keywords:** Electricity, office appliances, photovoltaic, power, solar.

ENGINEERING JOURNAL Volume 17 Issue 1

Received 29 May 2012

Accepted 31 July 2012

Published 1 January 2013

Online at <http://www.engj.org/>

DOI:10.4186/ej.2013.17.1.29

## 1. Introduction

One third of the world's population of six billion lives in developing countries. Many of these people lack access to modern energy services for economic and social development and some of their present energy systems are unsustainable. The emergence of perennial fuel crisis in most developing countries has drawn attention to the need for energy experts to further concentrate on producing viable alternatives [1].

The issue of sustainable development is gaining steady momentum. The renewable energies being inherently sustainable and environment friendly are gaining popularity. All developed countries and many developing countries in their energy planning have included renewable energies as important sources of energy for this century. Many countries are planning to develop renewable energies (solar, wind, hydro) to cover 10 to 40% of their energy needs within a couple of decades [2]. Therefore, the development of renewable source of energy should be taken with a greater sense of urgency.

Among the various types of renewable energy, special attention has been given to solar energy because it is freely available. According to Bolaji and Adu [3], solar energy is the driving force behind several of the renewable forms of energy. Solar energy is an ideal alternative source of energy because it is abundant, inexhaustible and renewable [4].

The photovoltaic system has very simple configuration. It has four main components: photovoltaic modules to convert sunlight into electrical energy; battery to store and deliver electrical energy in usable form; charge controller to regulate level of charging to and from the battery; and appliances such as lamps, computers, d.c. motor driven devices and telecommunication equipment.

Photovoltaic conversion is useful for several reasons. Conversion from sunlight to electricity is direct, so that bulky mechanical generator systems are unnecessary. The solar photovoltaic system has no moving parts, in the field, it requires only modest amount of skilled labour to install and maintain, making them well suited for developing countries. In order to supply the required power, the arrays should be capable of producing sufficient current and voltage to run the appliances, and it can be connected in series and in parallel to obtain the desired voltage and current, respectively.

Many researchers [3, 5-8] have in recent times designed, investigated and developed photovoltaic power system, which has been utilized in low to medium power applications such as in telecommunication stations, water pumping, refrigeration etc. This work is borne out from the need for alternative to the government own utility power supply, which is not reliable and epileptic in nature. In this paper, a solar photovoltaic system was developed to generate electricity for office use. The system was also tested to evaluate its performance.

## 2. Materials and Methods

### 2.1. Design of the Solar Power System

The energy balance on the solar panel is obtained by equating the total heat gained to the total heat loosed by the panel. Therefore,

$$GA_c = Q_u + Q_{\text{cond}} + Q_{\text{conv}} + Q_R + Q_\rho \quad (1)$$

where,  $G$  = rate of total radiation incident on the solar panel's surface ( $\text{W}/\text{m}^2$ );  $A_c$  = collector area ( $\text{m}^2$ );  $Q_u$  = rate of useful energy collected by the air ( $\text{W}$ );  $Q_{\text{cond}}$  = rate of conduction losses from the absorber ( $\text{W}$ );  $Q_{\text{conv}}$  = rate of convective losses from the absorber of solar panel ( $\text{W}$ );  $Q_R$  = rate of long wave re-radiation from the absorber of solar panel ( $\text{W}$ );  $Q_\rho$  = rate of reflection losses from the absorber of solar panel ( $\text{W}$ ). The three heat loss terms  $Q_{\text{cond}}$ ,  $Q_{\text{conv}}$  and  $Q_R$  are usually combined into one-term ( $Q_L$ ), i.e.

$$Q_L = Q_{\text{cond}} + Q_{\text{conv}} + Q_R \quad (2)$$

If  $\tau$  is the transmittance of the top glazing of solar panel and  $G_T$  is the total solar radiation incident on the top surface, therefore,

$$GA_c = \tau G_T A_c \quad (3)$$

The reflected energy from the absorber is given by the expression:

$$Q_{\rho} = \rho \tau G_T A_c \quad (4)$$

where  $\rho$  is the reflection coefficient of the absorber. Substitution of Eqs. (2), (3) and (4) in Eq. (1) yields:  $\tau G_T A_c = Q_u + Q_L + \rho \tau G_T A_c$  or  $Q_u = \tau G_T A_c (1 - \rho) - Q_L$ . For an absorber  $(1 - \rho) = \alpha$  and hence,

$$Q_u = (\alpha \tau) G_T A_c - Q_L \quad (5)$$

where  $\alpha$  is solar absorptance.  $Q_L$  composed of different convection and radiation parts. It is presented in the following form [9]:

$$Q_L = U_L A_c (T_c - T_a) \quad (6)$$

where,  $U_L$  = overall heat transfer coefficient of the absorber ( $\text{Wm}^{-2}\text{K}^{-1}$ );  $T_c$  = temperature of the collector's absorber (K);  $T_a$  = ambient air temperature (K). From Eqs. (5) and (6) the useful energy gained by the collector is expressed as:

$$Q_u = (\alpha \tau) G_T A_c - U_L A_c (T_c - T_a) \quad (7)$$

Therefore, the energy per unit area ( $q_u$ ) of the collector is

$$q_u = (\alpha \tau) G_T - U_L (T_c - T_a) \quad (8)$$

The thermal efficiency of the collector ( $\eta_c$ ) is defined as the ratio of the energy per unit area of the collector ( $q_u$ ) to the rate of total radiation incident on the collector's surface ( $G$ ):

$$\eta_c = \frac{q_u}{G} \quad (9)$$

Therefore, substitution of Eq. (8) in Eq. (9) gives:

$$\eta_c = \alpha \tau - \frac{U_L (T_c - T_a)}{G} \quad (10)$$

## 2.2. Simulation

An ideal solar cell may be modeled by a current source in parallel with a diode. Since, no solar cell in practice is ideal, so a shunt resistance ( $R_{sh}$ ) and a series resistance ( $R_s$ ) components are added to the model. The resulting equivalent circuit of a solar cell is shown in Fig. 1.

The equation which describes the  $I$ - $V$  characteristics of the cell is given as [3]:

$$I = I_L - I_o \left[ e^{\frac{q(V_L + IR_s)}{n\sigma T}} - 1 \right] \quad (11)$$

where,  $q$  = charge on an electron;  $n$  = diode quality factor;  $T$  = working temperature of cell;  $V_L$  = load voltage;  $I_o$  = saturation current of diode;  $I$  = current through  $R_s$ ; and  $I_L$  = load current.

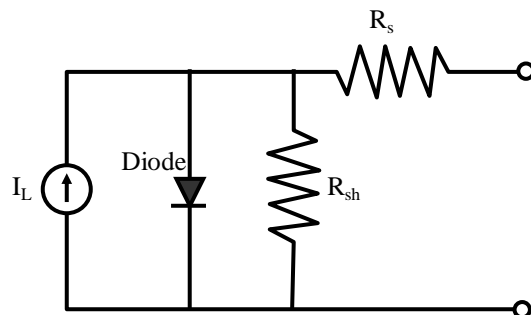

Fig. 1. Equivalent circuit of a solar cell [10].

A solar cell's energy conversion efficiency ( $\eta$ ), is the percentage of power converted when a solar cell is connected to an electrical circuit. This term is calculated using the ratio of the maximum power ( $P_m$ ) to the input solar irradiance ( $G$ , in  $\text{W}/\text{m}^2$ ) and the surface area of the solar cell ( $A_c$ , in  $\text{m}^2$ ) [11, 12]:

$$\eta = \frac{P_m}{GA_c} \quad (12)$$

### 2.3. Selection of the System Components

The schematic diagram of the solar photovoltaic power system is shown in Fig. 2. The system consists of a photovoltaic generator (solar panel), mounting frame, energy storage device, inverter, charge controller and wiring system.

#### 2.3.1. Photovoltaic Generator (Solar Panel)

The solar panel is a complex system that is made up of different elements. Presently, the materials for the construction of the solar panel is not available in the country, therefore, it was bought from the market at ₦65,000 Nigeria Naira. The solar module is of different sizes and specifications. The type used is made of mono crystalline silicon. It consists of 36 solar cells connected in series (Fig. 3). The module parameters specified by the manufacturer are: Irradiance =  $1.0 \text{ kW}/\text{m}^2$ ; spectral = AM 1.5; and cell temperature =  $25^\circ\text{C}$ . The surface of each cell is about  $155 \text{ mm} \times 155 \text{ mm}$  and the module surface is  $1400 \text{ mm} \times 625 \text{ mm}$ .

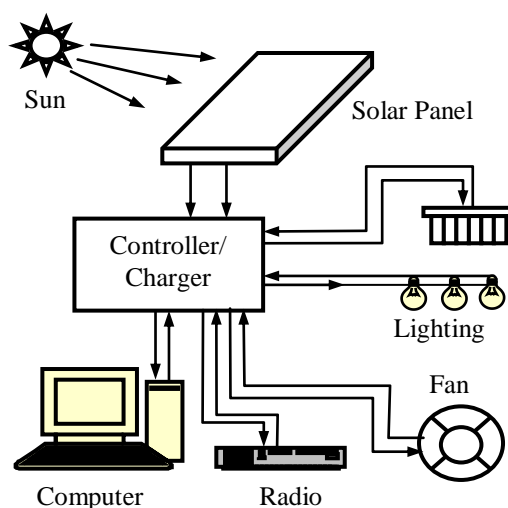

Fig. 2. Schematic of the PV- System for Electrification

#### 2.3.2. Mounting Frame

A fixed mounting frame was constructed to support the solar panel. The top surface of the mounting frame that will carry the solar panel is tilted and oriented to receive maximum solar radiation from the sun. The best stationary orientation is due south in the northern hemisphere and due north in southern hemisphere, therefore, the solar panel in this work is oriented facing south and tilted at  $17.15^\circ$  to the horizontal with the help of mounting frame. This is approximately  $10^\circ$  more than the local geographical latitude (Akure a location in Nigeria, Latitude  $7.15^\circ\text{N}$ ), which according to Adegoke and Bolaji [13], is the best recommended orientation for stationary absorber. This inclination is also to allow easy run off of water during the raining period.

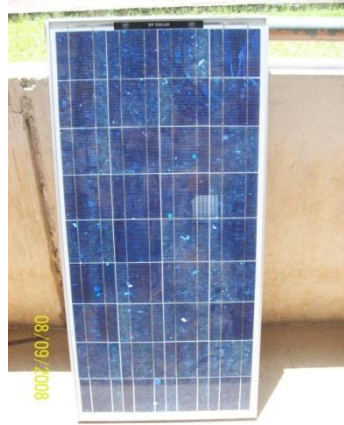

Fig. 3. Solar panel with 36 solar cells connected in series.

### 2.3.3. Energy Storage Device

The solar electric system in design required battery storage. The solar panels charge the battery during daylight hours and the battery supply the power when it is needed. The photovoltaic system makes use of rechargeable batteries. The rechargeable battery used in this work is the 12V, 120 Ah lead-acid type (Fig. 4). Lead-acid battery is used because of its low initial cost, its maintenance ability and because they are readily available. The battery operates in a parallel with a load and charging sources (solar panel and utility power) at an applied voltage, so that the battery takes a charge from the available charging source which is sufficient to maintain the cells in a fully charged condition indefinitely.



Fig. 4. 12V, 120 Ah lead-acid type.

### 2.3.4. Charge Controller

Measures must be taken to prevent excessive discharging and overcharging of the battery. There are two types of charge regulators; series and shunt. In small applications (up to about 100 V), a shunt regulator can be used to dissipate the unvalued power from generator. In larger applications, the battery is disconnected from the generator by means of a series regulator with the help of electromechanical switch (e.g. a relay) or

solid state device (bipolar transistors, MOSFET, etc.). In this work, a series controller is used. A transistorized switch is placed between the battery and the solar panel and on and off condition is controlled by battery voltage.

### 2.3.5. Inverter

Inverter is a standard item of electronics equipment which is used in converting the d.c. electricity into single-phase a.c. electricity used for powering a.c. appliances. In this work, 2 kW inverter was used to convert the d.c. from photovoltaic generator and battery to a.c. output.

### 2.3.6. Wiring System

The current expected to flow through a cable wire must be considered before choosing a wire for any particular application. Since the power to be carried is quite large (2 kW) and to prevent voltage loss between the solar PV panel and battery, all electrical wires used in the system are of size 50 mm<sup>2</sup>.

## 3. Installation of the System

The system was installed on the roof-top of the office building. Tests were carried out before the final installation of the system for easy accessibility to the system and measuring instruments. The solar power system was placed outdoor in an open place where radiation could be reached without any obstruction. Fig. 5 shows the set-up of solar power system during the tests. After the battery was fully charged, the 2 kW inverter was connected to the battery and switched on. The voltage on no-load shows the readings when no appliance was connected, while the voltage on load shows the output of the battery voltage when the electrical appliances were connected to the inverter.



Fig. 5. Set-up of solar power system.

## 4. Experimental Testing

The temperature of the solar panel was measured using electronics thermometer. The ambient temperature was also measured under shade to avoid the effect of direct solar radiation using electronic thermometer. The d.c. open circuit voltage ( $V_{oc}$ ) and load voltage ( $V_L$ ) were measured with the help of fluke 73 series multi-meter (connected in series). Short circuit current ( $I_{sc}$ ) and load current ( $I_L$ ) were measured with the help of ammeter (connected in series). The energy consumption in kWh was measured with the help of energy meter. Global solar insolation ( $G$ ) in W/m<sup>2</sup> was measured by thermoelectric pyranometer.

## 5. Results and Economics Discussion

The solar power system is designed to power appliances in the Mechanical Engineering Head of Department's office, Federal University of Technology Akure, Nigeria. The existing load in the office is shown on Table 1. The total cost of entire system as at July, 2008 was ₦129,500 Nigeria Naira. The cost analysis is shown in Table 2.

Table 1. The expected appliances to be powered by the solar power supply system.

<b>Appliance</b>	<b>Quantity</b>	<b>Power rating</b>
Printer	1	50
Laptop computer	1	65
Desktop computer	1	125
Ceiling fan	1	50
<b>Total power</b>		<b>290</b>

Table 2. Cost analysis.

<b>Item</b>	<b>Quantity</b>	<b>Unit Cost (₱)</b>	<b>Total Cost (₱)</b>
Battery (12V) (Deep cycle) 120AH	1	19,500	19,500
Charge controller	1	18,000	18,000
Inverter (12V/220V)	1	9,000	9,000
Transformer	1	6,500	6,500
Solar panel	1	65,000	65,000
Cable wires	Lots	4,500	4,500
Transportation	-	-	2,000
Miscellaneous	-	-	5,000
<b>Total</b>			<b>129,500</b>

The analysis of energy consumed by the appliances is shown on Table 3. The energy produced by a 12 V, 120 amp-hours battery is 1440 Wh (120 x 12). During the test, the battery discharges 10.55 Wh in eight working hours (Table 3), which is about 0.73% of its capacity.

Table 3. Analysis of energy consumed by the appliances.

<b>Appliance</b>	<b>Power rating (W)</b>	<b>Voltage (V)</b>	<b>Current (A)</b>	<b>Time (h)</b>	<b>Energy (Wh)</b>
Printer	50	220	0.227	8	1.82
Laptop computer	65	220	0.295	8	2.36
Desktop computer	125	220	0.568	8	4.55
Ceiling fan	50	220	0.227	8	1.82
<b>Total energy</b>					<b>10.55</b>

Similar daily results were obtained during the testing period (Figs. 6 and 7), since the office hours (08.00 – 16.00 h local time) coincide with the day-time when the solar power system is most active. Figures 6 and 7 show a typical day results of diurnal variation of ambient and solar panel temperatures for 1<sup>st</sup> and 3<sup>rd</sup> of September, 2008, respectively.

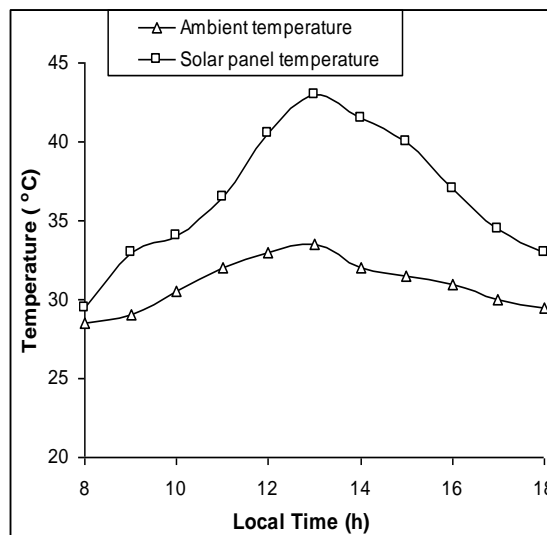

Fig. 6. A typical day results of variation of ambient and solar panel temperatures for 1<sup>st</sup> September, 2008.

As shown in these figures the temperature of solar panel is always higher than the ambient temperature. This indicates the absorption of solar radiation by the solar panel. The diurnal variation of battery output during the office hours is shown in Fig. 8. As shown in the figure, the battery output ranges from 12.28 to 12.38 V throughout the testing period with average voltage of 12.32 V, which provides regular and adequate input voltage for the proper functioning of the inverter.

Figure 9 shows a typical day results of the variation of solar insolation on the 1st of September, 2008. And Fig. 10 shows a typical day hourly results of photovoltaic power output. As shown in these figures, the system starts to generate electricity as early as 06.00 h and it continues till 18.00 h. The output of solar power system is a function of solar radiation. This is confirmed when compare Fig. 10 with Fig. 9, in Fig. 10, high output of solar power system occurred between 10.00 h and 16.00 h, which corresponds to the period of high solar radiation shown in Fig. 9.

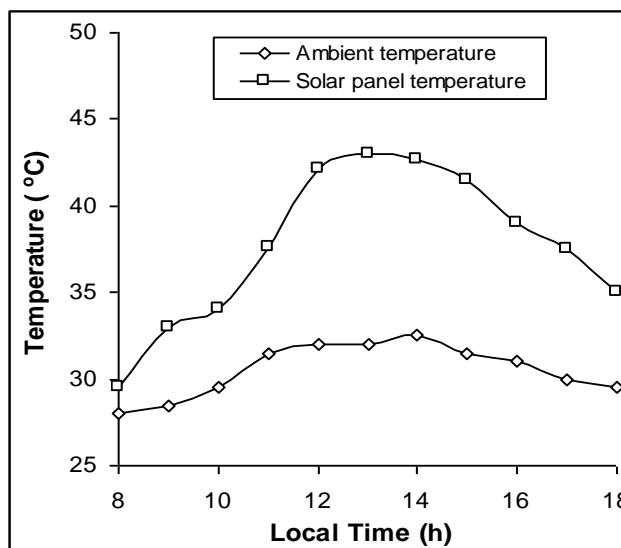

Fig. 7. A typical day results of variation of ambient and solar panel temperatures 3<sup>rd</sup> September, 2008.



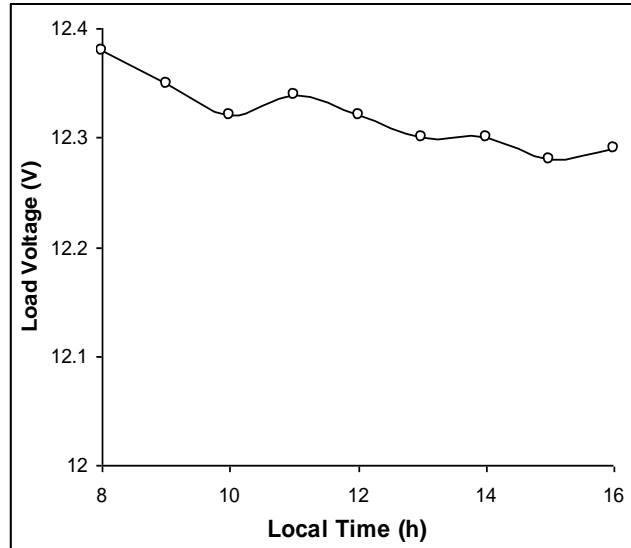

Fig. 8. Diurnal variation of battery output during the office hours.

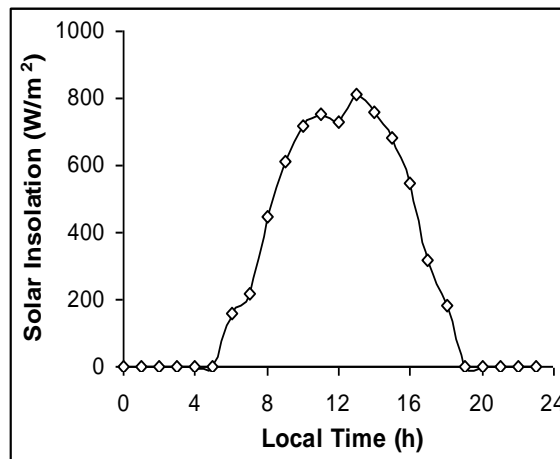

Fig. 9. A typical day results of the variation of solar insolation on the 1st of September, 2008.

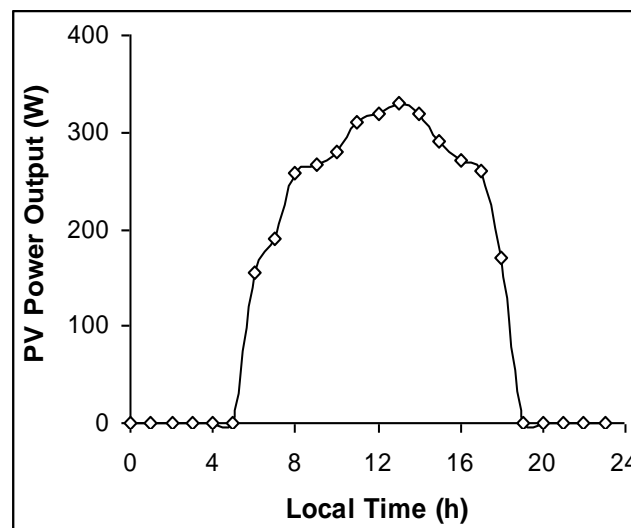

Fig. 10. A typical day hourly results of photovoltaic power output.

Fig. 11 shows the variation of PV power output with the solar panel temperature. As shown in the figure, power output increases as solar panel temperature increases. The results show that the power output increased about 9.2 W per 1°C increase of the solar panel temperature. The average solar power output obtained during the testing period was 344 W, which is far more than the total load of the office appliances of 290 W.

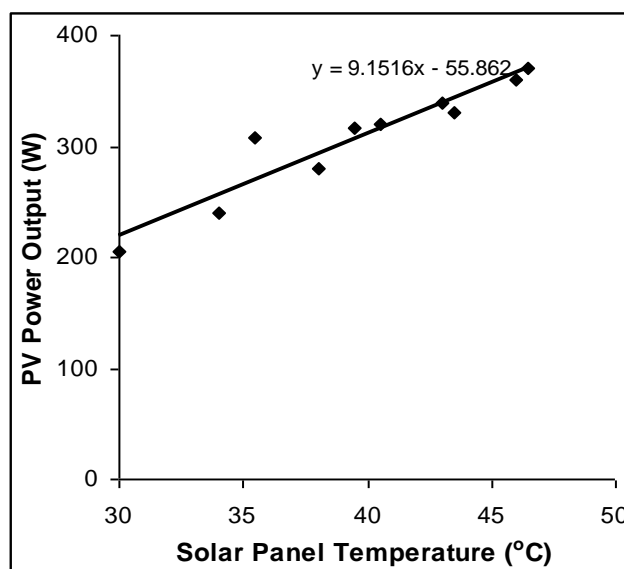

Fig. 11. Variation of PV power output with the solar panel temperature.

## 6. Conclusions

This work is borne out from the need for alternative to the government own utility power supply, which because of its unreliability and epileptic nature has paralyzed the day-to-day office work activities. Therefore, a solar photovoltaic power supply system was developed to generate electricity to power office appliances (one printer, one laptop computer, one desktop computer and ceiling fan) of total load of 290 W. The system consists of photovoltaic modules for converting sunlight into electrical energy, mounting frame, battery to store and deliver electrical energy in usable form, inverter for converting d.c. electricity from battery into single-phase a.c. electricity, charge controller for regulating level of charging and discharging to and from the battery, and wiring system.

The solar power system was tested in Akure Nigeria, on latitude 7.15°N and the results obtained showed a good performance of the system. The system starts to generate electricity as early as 06.00 h and it continues till 18.00 h, which amounts to 12 hours of electrical power generation. The office hours when the electricity is most needed fall in between this period of power generation. A voltage output ranges from 12.28 to 12.38 V was obtained during the test, which provided regular and adequate input voltage for the proper functioning of the inverter. The power output of the system was high between 10.00 h and 16.00 h, which correspond to the period of high solar radiation. An average solar power output of 334 W was obtained during the testing period, while the total load of office appliances carried by the system was 290 W.

## Acknowledgement

The authors wish to acknowledge the assistance of Mr. A. H. Adeleye, O. O. Cardoso, O. O. Ohioyenoye and O. A. Ogunlade, former students of Mechanical Engineering Department, Federal University of Technology Akure, Nigeria, in the area of construction and data collection when carrying out this research.

## References

- [1] O. A. Akinola, and B. O. Bolaji, "Sustainable energy technologies for poverty alleviation and environmental protection," *1<sup>st</sup> National Conference of Faculty of Science, University of Abuja, Nigeria*, July 18-20, 2006, pp. 53-63.
- [2] UNDP, "Energy for sustainable development," Online at: [http://www.undp.org/content/undp/en/home/librarypage/environment-energy/sustainable\\_energy/undp\\_and\\_energy\\_forsustainabledevelopment.html](http://www.undp.org/content/undp/en/home/librarypage/environment-energy/sustainable_energy/undp_and_energy_forsustainabledevelopment.html).
- [3] B. O. Bolaji, and M. R. Adu, "Design analysis of photovoltaic pumping system for rural application in Nigeria," *Int. J. Agric. Sci., Sci., Environ. Technol.*, vol. 6, no. 2, pp. 120-130, 2007.
- [4] G. M. Masters, *Renewable and Efficient Electric Power Systems*, Hoboken, Wiley, NJ, 2004.
- [5] K. Thomachan, and K. Srinivasan, "Photovoltaic panel generator based autonomous power source for small refrigeration units," *Sol. Energy*, vol. 56, pp. 543-552, 1996.
- [6] S. Q.-Kou, S. A. Klein, and W. A. Beckman, "A method for estimating the long-term performance of direct-coupled PV pumping systems," *Sol. Energy*, vol. 64, no. 1, pp. 33-40, 1998.
- [7] E. Beshada, M. Bux, and T. Waldenmaier, "Design optimization of a photovoltaic powered grain mill," *Agric. Eng. Int.: CIGR J.*, vol. 8, pp. 1-15, 2006.
- [8] J. O. Oni, and B. O. Bolaji, "Development of a universal DC power supply using solar photovoltaic, utility and battery power sources," *J. Energy S. Afr.*, vol. 22, no. 1, pp. 12-17, 2011.
- [9] N. K., Bansal, M. Kleemann, and M. Meliss, *Renewable Energy Sources and Conversion Technology*, Tata McGraww-Hill Publishing Company Ltd., New Delhil, 1990.
- [10] A. Aziz, K. Kassmi, F. Olivie, and A. Martinez, "Symbolization of the electric diagram of the marketed solar panels," *Moroccan J. Cond. Matt.*, vol. 7, no. 1, pp. 38-41, 2006.
- [11] S. Singer, and J. Appelbaum, "Starting characteristics of DC motor powered by solar cells", *IEEE T. Energy Conver.*, vol. 8, no. 1, pp. 47-53, 1993.
- [12] J. A. Merrigan, *Sunlight to Electricity: Photovoltaic Technology and Business Prospect*, 2nd ed., MIT Press Ltd., London, 1982.
- [13] C. O. Adegoke, and B. O. Bolaji, "Performance evaluation of solar-operated thermosyphon hot water system in Akure," *Int. J. Eng. Eng. Technol.*, vol. 2, no. 1, pp. 35-40, 2000.

